

Application Manual

Real Time Clock Module

RTC-8564JE/NB

Model	Product Number
RTC-8564JE	Q41856471000100
RTC-8564NB	Q41856491000200

NOTICE

- The material is subject to change without notice.
- Any part of this material may not be reproduced or duplicated in any form or any means without the written permission of Epson Toyocom.
- The information, applied circuit, program, usage etc., written in this material is just for reference. Epson Toyocom does not assume any liability for the occurrence of infringing any patent or copyright of a third party. This material does not authorize the licensing for any patent or intellectual copyrights.
- Any product described in this material may contain technology or the subject relating to strategic products under the control of the Foreign Exchange and Foreign Trade Law of Japan and may require an export licence from the Ministry of International Trade and industry or other approval from another government agency.
- You are requested not to use the products (and any technical information furnished, if any) for the development and/or manufacture of weapon of mass destruction or for other military purposes. You are also requested that you would not make the products available to any third party who may use the products for such prohibited purposes.
- These products are intended for general use in electronic equipment. When using them in specific applications that require extremely high reliability such as applications stated below, it is required to obtain the permission from Epson Toyocom in advance.
 - / Space equipment (artificial satellites, rockets, etc) / Transportation vehicles and related (automobiles, aircraft, trains, vessels, etc) / Medical instruments to sustain life / Submarine transmitters
 - / Power stations and related / Fire work equipment and security equipment / traffic control equipment
 - / and others requiring equivalent reliability.
- In this manual for Epson Tyocom, product code and marking will still remain as previously identified prior to the merger. Due to the on going strategy of gradual unification of part numbers, please review product code and marking as they will change during the course of the coming months. We apologize for the inconvenience, but we will eventually have a unified part numbering system for Epson Toyocom which will be user friendly.

CONTENTS

1. Overview.....	1
2. Block diagram.....	1
3. Terminal description	2
3.1. Terminal connections	2
3.2. Pin Functions.....	2
4. External Dimensions / Marking Layout.....	3
4.1. External Dimensions.....	3
4.2. Marking Layout.....	3
5. Absolute Maximum Ratings	4
6. Recommended operating conditions	4
7. Frequency Characteristics.....	4
8. Electrical Characteristics.....	5
8.1. DC characteristics	5
8.2. AC electrical characteristics.....	6
9. Reference data	7
10. External connection example.....	8
11. Application notes	9
12. Overview of Functions and Description of Registers	10
12.1. Overview of Functions	10
12.2. Register table	11
13. Description of Functions	12
13.1. Description of registers.....	12
13.1.1. Control register 1 (Reg – 00 [h])	12
13.1.2. Control register 2 (Reg – 01 [h])	13
13.1.3. Clock counter (Reg – 02 [h] to 04 [h])	14
13.1.4. Calendar counter (Reg – 05 [h] , 07 [h] , 08 [h])	15
13.1.5. Day counter (Reg – 6[h]).....	15
13.1.6. Alarm registers (Reg – 09 [h] to 0C [h])	16
13.1.7. Timer setting register (Reg – 0E [h]).....	16
13.1.8. Down counter for fixed-cycle timer (Reg – 0F [h])	16
13.1.9. CLKOUT output register (Reg - 0D [h]).....	17
13.2. Fixed-cycle Timer Interrupt Function.....	18
13.3. Alarm Interrupt Function.....	25
13.4. /INT "L" Interrupt Output When Interrupt Function Operates.....	28
13.5. Flow Charts.....	29
13.6. Reading/Writing Data via the I ² C Bus Interface.....	32

3. Terminal description

3.1. Terminal connections

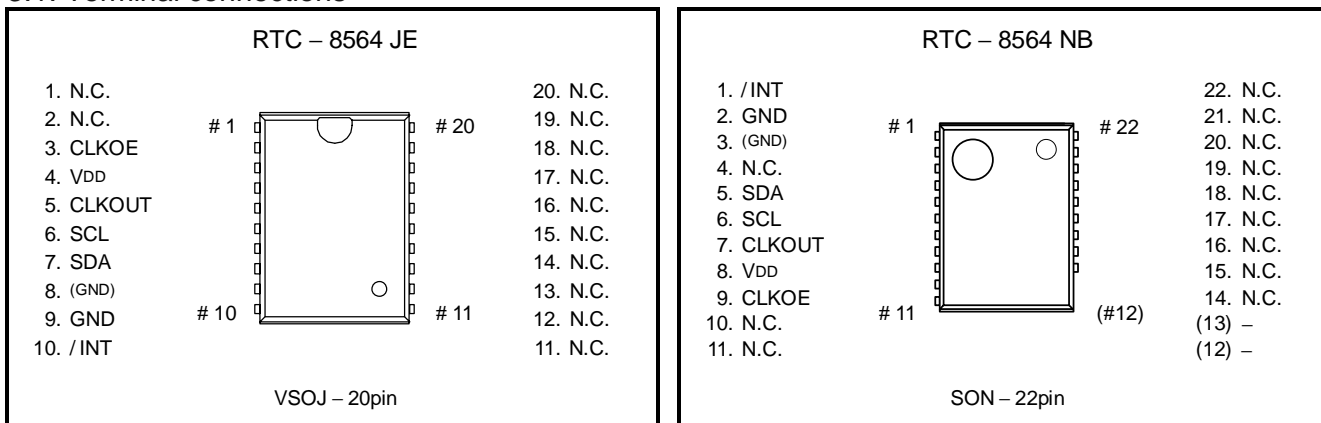

3.2. Pin Functions

Signal name	I/O	Function													
SCL	Input	This is the serial clock input pin for I ² C Bus communications.													
SDA	Bi-Directional	This pin's signal is used for input and output of address, data, and ACK bits, synchronized with the serial clock used for I ² C communications. Since the SDA pin is an N-ch open drain pin during output, be sure to connect a suitable pull-up resistance relative to the signal line capacity.													
CLKOUT	Output	The CLKOUT pin is a clock output pin (C-MOS output) with the output control function. The CLKOE pin can be used in combination with the FE bit, FD1 bit, and FD0 bit to control the output mode of the CLKOUT output pin. The CLKOE input pin can be used in combination with the FE bit, FD1 bit, and FD0 bit to select the frequency output from the CLKOUT output pin (32.768 kHz, 1024 Hz, 32 Hz, or 1 Hz) or to stop output. When output is stopped, the CLKOUT output pin is at low level (= " L ").													
CLKOE	Input	<table border="1" style="width: 100%; border-collapse: collapse; margin-bottom: 5px;"> <thead> <tr> <th style="width: 25%;">CLKOE pin input</th> <th style="width: 25%;">FE bit</th> <th style="width: 50%;">CLKOUT pin output</th> </tr> </thead> <tbody> <tr> <td rowspan="2" style="text-align: center;">" H "</td> <td style="text-align: center;">1</td> <td style="text-align: center;">Output (C-MOS)</td> </tr> <tr> <td style="text-align: center;">0</td> <td style="text-align: center;">OFF (" L ")</td> </tr> <tr> <td rowspan="2" style="text-align: center;">" L "</td> <td style="text-align: center;">1</td> <td style="text-align: center;">OFF (" L ")</td> </tr> <tr> <td style="text-align: center;">0</td> <td style="text-align: center;">OFF (" L ")</td> </tr> </tbody> </table> <p>During the initial power-on (when power is applied from 0 V), if the CLKOE input pin is at high level (= " H "), the power-on reset function selects 32.768 kHz as the frequency.</p>	CLKOE pin input	FE bit	CLKOUT pin output	" H "	1	Output (C-MOS)	0	OFF (" L ")	" L "	1	OFF (" L ")	0	OFF (" L ")
CLKOE pin input	FE bit	CLKOUT pin output													
" H "	1	Output (C-MOS)													
	0	OFF (" L ")													
" L "	1	OFF (" L ")													
	0	OFF (" L ")													
/INT	Output	This pin outputs alarm signals, fixed timer interrupt signals, and other interrupt signals at low level (= " L "). This pin is an open drain pin.													
VDD	–	This pin connects to the plus side of the power.													
GND	–	This pin connects to the minus side (ground) of the power.													
N.C.	–	This pin is not connected internally. But , In RTC-8564NB(SON-22pin), all pins from 14 pin to 22 pin are connected with inside frame mutually. Use OPEN, or GND or VDD to connect.													

Note : Be sure to connect a bypass capacitor rated at least 0.1 μF between VDD and GND.

4. External Dimensions / Marking Layout

4.1. External Dimensions

RTC – 8564 JE (VSOJ – 20pin)

• External dimensions

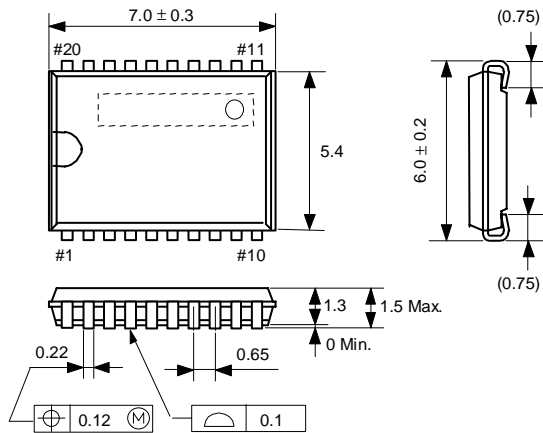

• Recommended soldering pattern

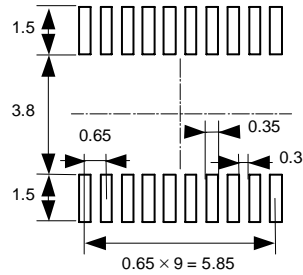

Unit : mm

* The cylinder of the crystal oscillator can be seen in this area (back and front), but it has no affect on the performance of the device.

RTC – 8564 NB (SON – 22pin)

• External dimensions

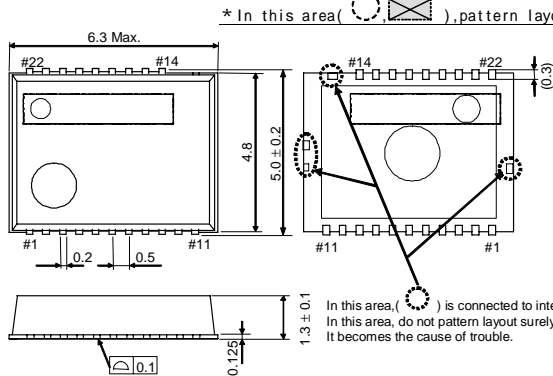

* In this area (), pattern layout is not allowed.

• Soldering pattern

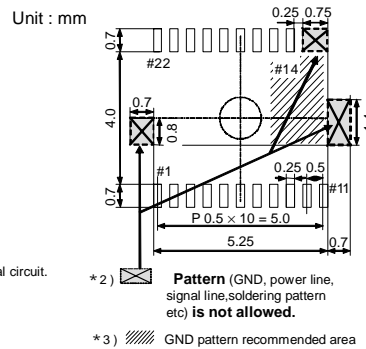

Unit : mm

* 1) The cylinder of the crystal oscillator may be exposed in this area (top and bottom), however it has no affect on the performance of the device.

* 2) Pattern (GND, power line, signal line, soldering pattern, etc) is not allowed. In this area, at a parts side of board, do not pattern layout surely.

* In an area () of the product bottom side, a terminal connected to an IC inside is exposed. When the circuit pattern contacts those terminal, it will cause serious obstruction to the oscillation, function or electronic spec.

* 3) It is the best design that there is no signal line in this area. Please fill it up with GND pattern if possible.

4.2. Marking Layout

RTC – 8564 JE (VSOJ – 20pin)

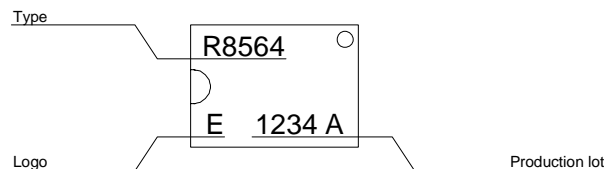

RTC – 8564 NB (SON – 22pin)

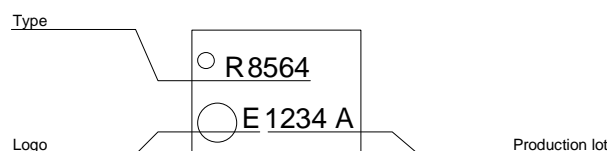

* Contents displayed indicate the general markings and display, but are not the standards for the fonts, sizes and positioning.

5. Absolute Maximum Ratings

GND = 0 V

Parameter	Symbol	Condition	Rating	Unit
Supply Voltage	V _{DD}	Between V _{DD} and GND	-0.5 to +6.5	V
Supply Voltage	I _{DD}	V _{DD} pin	-50 to 50	mA
Input Voltage	V _I	Input pin	GND-0.5 to V _{DD} +0.5	V
Output Voltage	V _O	/INT pin	GND-0.5 to V _{DD} +0.5	V
DC Input Current	I _I		-10 to 10	mA
DC Output Current	I _O		-10 to 10	mA
Storage Temperature Range	T _{STG}	Stored bare product after unpacking	-55 to +125	°C

6. Recommended operating conditions

GND = 0 V

Item	Symbol	Condition	Rating	Unit
Operating supply voltage	V _{DD}	I ² C-BUS access at 400 kHz	1.8 to 5.5	V
Clock supply voltage	V _{DD}		V _{LOW} ^{(*)1} to 5.5	V
Operating temperature	T _{OPR}	No condensation	-40 to +85	°C

*1) See " 8.1. DC Electrical Characteristics ".

7. Frequency Characteristics

* Unless otherwise specified, GND = 0 V
 , Ta = +25 °C , V_{DD} = 3.0 V

Item	Symbol	Comments	Min.	Typ.	Max.	Unit
Output frequency	f _o			32.768	(Typ.)	kHz
Frequency precision	Δ f / f	Ta = +25 °C V _{DD} = 3.0 V		5 ± 23	(*)1 (*)2	× 10 ⁻⁶
Frequency voltage characteristics	f / V	Ta = +25 °C V _{DD} = 1.0 V to 5.5 V		± 2	(Max.)	× 10 ⁻⁶ / V
Frequency temperature characteristics	T _{op}	Ta = -10 °C to +70 °C, V _{DD} = 3.0 V ; Reference at +25 °C	-120		+10	× 10 ⁻⁶
Oscillation startup-up time	t _{STA}	Ta = +25 °C V _{DD} = 1.8 V			3.0	s
Aging	f _a	Ta = +25 °C , V _{DD} = 3.0 V ; first year	-5		+5	× 10 ⁻⁶ / year

*1) This difference is 1 minute by 1 month. (excluding offset)

8. Electrical Characteristics

8.1. DC characteristics

* Unless otherwise specified, GND = 0 V, V_{DD} = 1.8 V to 5.5 V, Ta = -40 °C to +85 °C

Item	Symbol	Condition	Min.	Typ.	Max.	Unit
Current consumption * interface active	I _{DD}	f _{SCL} = 400 kHz			800	μA
		f _{SCL} = 100 kHz			200	μA
Current consumption * interface inactive (f _{SCL} = 0 Hz) * CLKOUT = disabled (CLKOE = GND)	I _{DD}	f _{SCL} = 0 Hz, V _{DD} = 5.0 V		330	800	nA
		f _{SCL} = 0 Hz, V _{DD} = 3.0 V		275	700	nA
		f _{SCL} = 0 Hz, V _{DD} = 2.0 V		250	650	nA
Current consumption * interface inactive (f _{SCL} = 0 Hz) * CLKOUT = 32 kHz output (LOAD is 0 pF)	I _{DD32K}	f _{SCL} = 0 Hz, V _{DD} = 5.0 V		2.5	3.4	μA
		f _{SCL} = 0 Hz, V _{DD} = 3.0 V		1.5	2.2	μA
		f _{SCL} = 0 Hz, V _{DD} = 2.0 V		1.1	1.6	μA
"L" input voltage	V _{IL}		GND - 0.5		0.3 × V _{DD}	V
"H" input voltage	V _{IH}		0.7 × V _{DD}		V _{DD} + 0.5	V
"L" output current	I _{OL} (SDA)	V _{OL} = 0.4 V, V _{DD} = 5 V	-3			mA
"L" output current	I _{OL} (/INT)	V _{OL} = 0.4 V, V _{DD} = 5 V	-1			mA
"L" output current	I _{OL} (CLKOUT)	V _{OL} = 0.4 V, V _{DD} = 5 V	-1			mA
"H" output current	I _{OH} (CLKOUT)	V _{OH} = 4.6 V, V _{DD} = 5 V			1	mA
Leakage current	I _{LO}	V _O = V _{DD} or GND	-1		1	μA
Low voltage detection	V _{LOW}	Ta = -20 °C to +70 °C		0.9	1.0	V
		Ta = -40 °C to +85 °C		0.9	1.1	V

8.2. AC electrical characteristics

* Unless otherwise specified, GND = 0 V , VDD = 1.8 V to 5.5 V , Ta = -40 °C to +85 °C

Item	Symbol	Condition	Min.	Typ.	Max.	Unit
SCL clock frequency	fSCL				400	kHz
Start condition set-up time	tSU; STA		0.6			μs
Start condition hold time	tHD; STA		0.6			μs
Data set-up time	tSU; DAT		100			ns
Data hold time	tHD; DAT		0			ns
Stop condition set-up time	tSU; STO		0.6			μs
Bus free time between a STOP and START condition	tBUF		1.3			μs
SCL "L" time	tLOW		1.3			μs
SCL "H" time	tHIGH		0.6			μs
SCL and SDA rise time	tr				0.3	μs
SCL and SDA fall time	tf				0.3	μs
Tolerance spike time on bus	tSP				50	ns

Timing chart

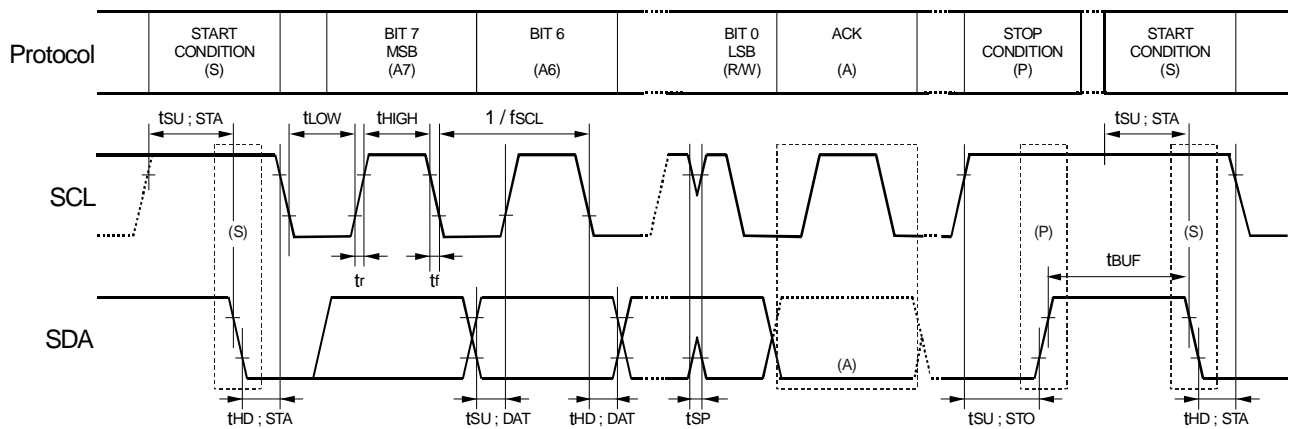

Note :

(1) I²C access time between a START and a START condition or between a START and a STOP condition to this device must be less than one second.

(2)Data writing :

It's necessary to input the data of 8-bit units. During inputting the data of 8-bit units, a state of suspension occurs, the data are not written appropriately.

9. Reference data

(1) Example of frequency and temperature characteristics [Finding the frequency stability]

1. Frequency and temperature characteristics can be approximated using the following equations.

$$\Delta f_T = \alpha (\theta_T - \theta_X)^2$$

- Δf_T : Frequency deviation in any temperature
- $\alpha [1 / ^\circ\text{C}^2]$: Coefficient of secondary temperature $(-0.035 \pm 0.005) \times 10^{-6} / ^\circ\text{C}^2$
- $\theta_T [^\circ\text{C}]$: Ultimate temperature $(+25 \pm 5 ^\circ\text{C})$
- $\theta_X [^\circ\text{C}]$: Any temperature

2. To determine overall clock accuracy, add the frequency precision and voltage characteristics.

$$\Delta f/f = \Delta f/f_0 + \Delta f_T + \Delta f_V$$

- $\Delta f/f$: Clock accuracy (stable frequency) in any temperature and voltage.
- $\Delta f/f_0$: Frequency precision
- Δf_T : Frequency deviation in any temperature.
- Δf_V : Frequency deviation in any voltage.

3. How to find the date difference

$$\text{Date Difference} = \Delta f/f \times 86400(\text{Sec})$$

* For example: $\Delta f/f = 11.574 \times 10^{-6}$ is an error of approximately 1 second/day.

(2) Current and voltage consumption characteristics

(2-1) Current consumption when non-accessed (i) when CLKOUT=OFF

(2-2) Current consumption when non-accessed (ii) when CLKOUT=32.768kHz

10. External connection example

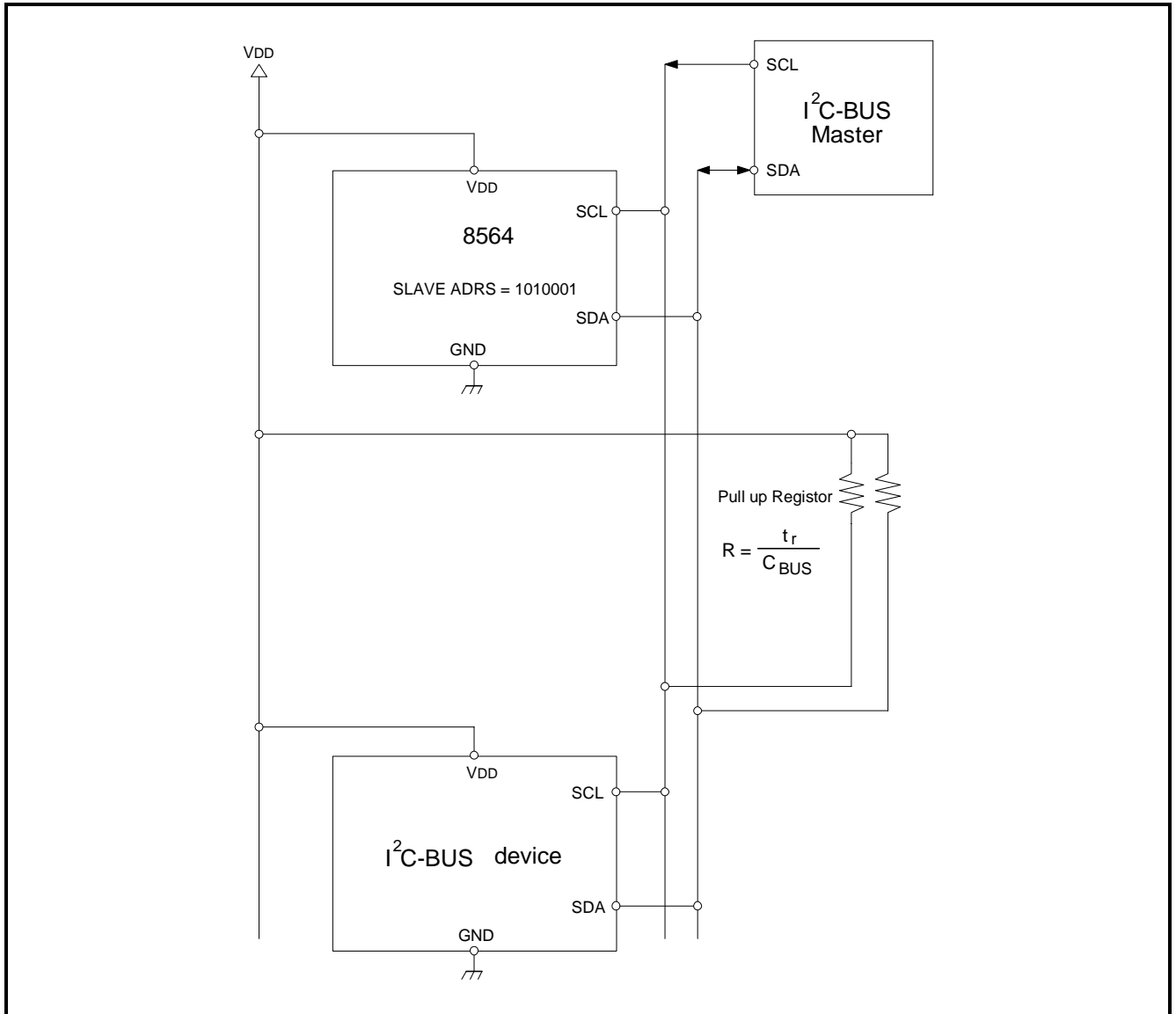

11. Application notes

1) Notes on handling

This module uses a C-MOS IC to realize low power consumption. Carefully note the following cautions when handling.

(1) Static electricity

While this module has built-in circuitry designed to protect it against electrostatic discharge, the chip could still be damaged by a large discharge of static electricity. Containers used for packing and transport should be constructed of conductive materials. In addition, only soldering irons, measurement circuits, and other such devices which do not leak high voltage should be used with this module, which should also be grounded when such devices are being used.

(2) Noise

If a signal with excessive external noise is applied to the power supply or input pins, the device may malfunction or "latch up." In order to ensure stable operation, connect a filter capacitor (preferably ceramic) of greater than $0.1 \mu\text{F}$ as close as possible to the power supply pins (between VDD and GNDs). Also, avoid placing any device that generates high level of electronic noise near this module.

* Do not connect signal lines to the shaded area in the figure shown in Fig. 1 and, if possible, embed this area in a GND land.

(3) Voltage levels of input pins

When the input pins are at the mid-level, this will cause increased current consumption and a reduced noise margin, and can impair the functioning of the device. Therefore, try as much as possible to apply the voltage level close to VDD or GND.

(4) Handling of unused pins

Since the input impedance of the input pins is extremely high, operating the device with these pins in the open circuit state can lead to unstable voltage level and malfunctions due to noise. Therefore, pull-up or pull-down resistors should be provided for all unused input pins.

2) Notes on packaging

(1) Soldering heat resistance.

If the temperature within the package exceeds $+260 \text{ }^\circ\text{C}$, the characteristics of the crystal oscillator will be degraded and it may be damaged. The reflow conditions within our reflow profile is recommended. Therefore, always check the mounting temperature and time before mounting this device. Also, check again if the mounting conditions are later changed.

* See Fig. 2 profile for our evaluation of Soldering heat resistance for reference.

(2) Mounting equipment

While this module can be used with general-purpose mounting equipment, the internal crystal oscillator may be damaged in some circumstances, depending on the equipment and conditions. Therefore, be sure to check this. In addition, if the mounting conditions are later changed, the same check should be performed again.

(3) Ultrasonic cleaning

Depending on the usage conditions, there is a possibility that the crystal oscillator will be damaged by resonance during ultrasonic cleaning. Since the conditions under which ultrasonic cleaning is carried out (the type of cleaner, power level, time, state of the inside of the cleaning vessel, etc.) vary widely, this device is not warranted against damage during ultrasonic cleaning.

(4) Mounting orientation

This device can be damaged if it is mounted in the wrong orientation. Always confirm the orientation of the device before mounting.

(5) Leakage between pins

Leakage between pins may occur if the power is turned on while the device has condensation or dirt on it. Make sure the device is dry and clean before supplying power to it.

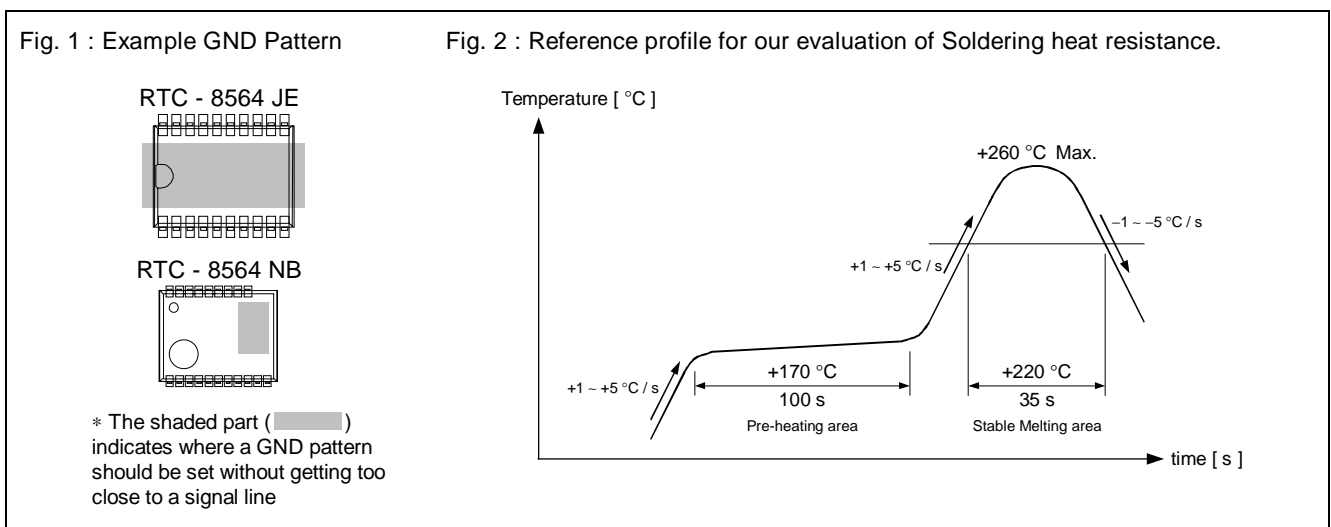

12. Overview of Functions and Description of Registers

12.1. Overview of Functions

1) Clock functions

This function is used to set and read out month, day, hour, date, minute, second, and year (last two digits) data. Any (two-digit) year that is a multiple of 4 is treated as a leap year and calculated automatically as such until the year 2099.

* For details, see "13.1. Description of Registers".

2) Fixed-cycle interrupt generation function

The fixed-cycle timer interrupt generation function generates an interrupt event periodically at any fixed cycle set between 244.14 μ s and 255 minutes.

When an interrupt event is generated, the /INT pin goes to low level ("L") and "1" is set to the TF bit to report that an event has occurred.

Two types of operations can be selected for this function (level interrupt mode and repeated interrupt mode).

* For details, see "13.2. Fixed-cycle Interrupt Function".

3) Alarm interrupt function

The alarm interrupt generation function generates interrupt events for alarm settings such as date, day, hour, and minute settings.

When an interrupt event occurs, the AF bit value is set to "1" and the /INT pin goes to low level to indicate that an event has occurred.

* For details, see "13.3. Alarm Interrupt Function".

4) 32.768 kHz output function

The 32.768 kHz clock signal (with precision equal to that of the on-chip crystal oscillator) can be output (as CMOS output) via the CLKOUT pin.

If a different frequency is required, 32.768 kHz, 1024 Hz, 32 Hz, or 1 Hz can be selected.

* For details, see "13.1.9. CLKOUT output register".

12.2. Register table

Address [h]	Function	bit 7	bit 6	bit 5	bit 4	bit 3	bit 2	bit 1	bit 0	note
00	Control 1	TEST	0	STOP	0	TEST	0	0	0	*3 , *4
01	Control 2	0	×	0	TI / TP	AF	TF	AIE	TIE	*4 , *5
02	Seconds	VL	40	20	10	8	4	2	1	*1
03	Minutes	×	40	20	10	8	4	2	1	*5
04	Hours	×	×	20	10	8	4	2	1	*5
05	Days	×	×	20	10	8	4	2	1	*5
06	Weekdays	×	×	×	×	×	4	2	1	*5
07	Months / Century	C	×	×	10	8	4	2	1	*5
08	Years	80	40	20	10	8	4	2	1	
09	Minute Alarm	AE	40	20	10	8	4	2	1	
0A	Hour Alarm	AE	×	20	10	8	4	2	1	*5
0B	Day Alarm	AE	×	20	10	8	4	2	1	*5
0C	Weekday Alarm	AE	×	×	×	×	4	2	1	*5
0D	CLKOUT frequency	FE	×	×	×	×	×	FD1	FD0	*2 , *5
0E	Timer control	TE	×	×	×	×	×	TD1	TD0	*5
0F	Timer	128	64	32	16	8	4	2	1	

Note) During the initial power-on (from 0 V) and if the value of the VL bit is "1" when the VL bit is read, be sure to initialize all registers before using them.
When doing this, be careful to avoid setting incorrect data as the date or time, as timed operations cannot be guaranteed if incorrect date or time data has been set.

- *1. During the initial power-on (from 0 V), the power-on reset function sets "1" to the VL bit.
* Since the value of other registers is undefined at this time, be sure to reset all registers before using them.
- *2. During the initial power-on (from 0 V), the power-on reset function sets "1" to the FE bit and the FD1 and FD0 bits are reset to "0".
* If the CLKOE input pin is at high level ("H"), output from the CLKOUT output pin is at 32.768 kHz.
- *3. The two TEST bits for address 00 (Control 1) are for use by Seiko Epson Corporation.
When initializing, be sure to write "0". Afterward, be sure to write "0" whenever writing to these bits.
* This device's operations are not guaranteed if "1" has been set to any of these bits.
- *4. All bits marked with "0" should have a value of "0" after initialization.
- *5. All bits marked with "x" are read-only bits whose value when read is undefined. Be sure to mask these bits after they are read.

13. Description of Functions

13.1. Description of registers

13.1.1. Control register 1 (Reg – 00 [h])

Address [h]	Function	bit 7	bit 6	bit 5	bit 4	bit 3	bit 2	bit 1	bit 0
00	Control 1	TEST	0	STOP	0	TEST	0	0	0

- This register is used to control stopping and starting of the clock function, calendar function, and other functions.

1) TEST bits (bit 7 and bit 3)

These two TEST bits are for use by Seiko Epson Corporation.

When initializing, be sure to write "0". Afterward, be sure to write "0" whenever writing to these bits.

* This device's operations are not guaranteed if "1" has been set to any of these bits.

2) STOP bit

The STOP bit is used to stop functions such as the clock, calendar, alarm, and timer.

Writing "1" to the STOP bit stops operation of the clock, calendar, alarm, timer, etc.

- *1) When the STOP bit = "1", operations are restricted.
Do not use any settings other than the clock and calendar settings.
- *2) When the STOP bit = "1", output via CLKOUT may be stopped, depending on the selected frequency.
Note this with caution.
 - (1) If 32.768 kHz has been selected as the output frequency, output will continue at 32.768 kHz.
 - (2) If any other output frequency was selected (1024 Hz, 32 Hz, or 1 Hz), CLKOUT output is stopped.
- *3) When the STOP bit = "1", the I²C-BUS bus timeout function is disabled. Note this with caution.

When the STOP bit = "0", these operations are resumed (stop mode is canceled).

- * 0.5 seconds after the STOP bit value is changed from "1" to "0", the "second" value is updated (without waiting for a full second to elapse). This operation occurs once only after changing the STOP bit value.
(This is done to keep the error margin to within ±0.5 seconds in relation to the actual time whenever the clock value is changed via any timing.)

13.1.2. Control register 2 (Reg – 01 [h])

Address [h]	Function	bit 7	bit 6	bit 5	bit 4	bit 3	bit 2	bit 1	bit 0
01	Control 2	0	×	0	TI / TP	AF	TF	AIE	TIE

• This register is used to monitor various interrupt event settings and the conditions under which various interrupt-related events occur.

1) TI / TP bit (Interrupt Signal Output Mode Select. Interrupt / Periodic)

When a fixed-cycle timer interrupt event occurs (when the TF bit goes from "0" to "1") , this bit specifies whether the interrupt operation occurs just once or repeatedly.

Writing "1" to this bit sets repeated operation.

Writing "0" to this bit sets single-shot operation.

* For details, see "9.2. Fixed-cycle Timer Interrupt Function ".

2) AF bit (Alarm Flag)

This is a flag bit that retains the result when an alarm interrupt event has been detected.

When an alarm interrupt event occurs, this bit's value changes from "0" to "1".

* For details, see "9.3. Alarm Interrupt Function".

3) TF bit (Timer Flag)

This is a flag bit that retains the result when a fixed-cycle timer interrupt event has been detected.

When a fixed-cycle timer interrupt event occurs, this bit's value changes from "0" to "1".

* For details, see "9.2. Fixed-cycle Timer Interrupt Function ".

4) AIE bit (Alarm Interrupt Enable)

This bit sets the operation of the /INT interrupt signal when an alarm interrupt event has occurred (the AF bit value changes from "0" to "1").

When a "1" is written to this bit, occurrence of an interrupt event causes a low-level interrupt signal to be output from /INT pin.

Writing "0" to this bit prohibits low-level output from the /INT pin.

* For details, see "9.3. Alarm Interrupt Function".

5) TIE bit (Timer Interrupt Enable)

This bit sets the operation of the /INT interrupt signal when a fixed-cycle interrupt event has occurred (the TF bit value changes from "0" to "1").

When a "1" is written to this bit, occurrence of an interrupt event causes a low-level interrupt signal to be output from /INT pin.

Writing "0" to this bit prohibits low-level output from the /INT pin.

* For details, see "9.2. Fixed-cycle Timer Interrupt Function ".

13.1.3. Clock counter (Reg – 02 [h] to 04 [h])

Address [h]	Function	bit 7	bit 6	bit 5	bit 4	bit 3	bit 2	bit 1	bit 0
02	Seconds	VL	40	20	10	8	4	2	1
03	Minutes	×	40	20	10	8	4	2	1
04	Hours	×	×	20	10	8	4	2	1

- The clock counter counts seconds, minutes, and hours.
- The data format is BCD format. For example, when the "seconds" register value is "0101 1001" it indicates 59 seconds.

- * When overwriting time data, we recommend setting "1" to the STOP bit to stop the clock before overwriting. (This prevents unintentional carry operations from occurring while overwriting data.)
- * Note with caution that writing non-existent time data may interfere with normal operation of the clock counter.

1) [Seconds] register (Reg – 02 [h])

This counter counts seconds.
Count values are updated as: 00 seconds, 01 second, 02 to 59 seconds, 00 seconds, 01 second, etc. in that order.

2) [Minutes] register (Reg – 03 [h])

This counter counts minutes.
Count values are updated as: 00 minutes, 01 minute, 02 to 59 minutes, 00 minutes, 01 minute, etc. in that order.

3) [Hours] register (Reg – 04 [h])

The [Hours] counter uses a 24-hour clock.
Count values are updated as: 00 hours, 01 hour, 02 to 23 hours, 00 hours, 01 hour, etc. in that order.

4) VL bit (Voltage Low Flag)

This is a flag bit that retains the result when detecting low voltage.
When the power source's voltage drops below VLOW[V], this flag is set to 1.
If this bit's value is "1" when read, this RTC's data is ignored, in which case all registers should be initialized before being used.

- (1) A "1" is set to this VL flag during initial power-on (from 0 V).
Since the value of other registers is undefined at this time, be sure to reset all registers before using them.
- (2) When recovering from backup mode, read this VL flag, and if its value is "1" be sure to initialize the registers before using them.
- (3) When initializing, be sure to clear this VL flag to zero to prepare for the next voltage detection.
- (4) This VL flag was designed to provide a voltage drop warning after the voltage of the backup battery or other devices has gradually dropped, and it is not designed to respond to sharp fluctuations in voltage due to power supply chatter, etc.

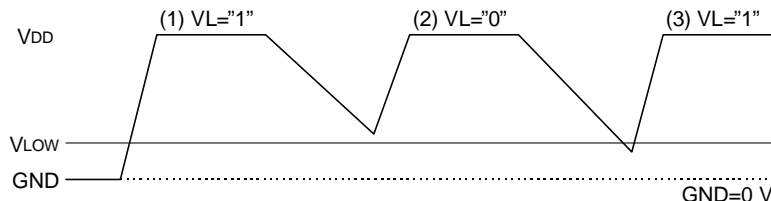

- (1) VL="1" as result of initial supply of power
- (2) When the power supply is low but voltage not dropping to VLow, VL remains at "0" with no change
- (3) When the power supply is low and voltage dropping below VLow, VL becomes "1".

* The value of the VL bit in (2) and (3) need to be zero cleared in (1).

- (5) This VL flag is cleared via a write operation regardless of data.
Be sure to read this flag's value before writing to this register.

13.1.4. Calendar counter (Reg – 05 [h] , 07 [h] , 08 [h])

Address [h]	Function	bit 7	bit 6	bit 5	bit 4	bit 3	bit 2	bit 1	bit 0
05	Days	×	×	20	10	8	4	2	1
07	Months / Century	C	×	×	10	8	4	2	1
08	Years	80	40	20	10	8	4	2	1

- The auto calendar function updates all dates, months, and years from January 1, 2001 to December 31, 2099.
- The data format is BCD format. For example, a date register value of "0011 0001" indicates the 31st.
- * Note with caution that writing non-existent date data may interfere with normal operation of the calendar counter.

1) [Day] register (Reg – 05 [h])

- This is the date counter.
Updating of this counter varies depending on the month.
- * A leap year is set whenever the year value is a multiple of four (such as 04, 08, 12, 88, 92, or 96). In February of a leap year, the counter counts dates from "01," "02," "03," to "28," "29," "01," etc.

[Days]	Month	Date update pattern
Write / Read	1, 3, 5, 7, 8, 10, or 12	01, 02, 03 ~ 30, 31, 01 ~
	4, 6, 9, or 11	01, 02, 03 ~ 30, 01, 02 ~
	February in normal year	01, 02, 03 ~ 28, 01, 02 ~
	February in leap year	01, 02, 03 ~ 28, 29, 01 ~

2) [Months / Century] register (Reg – 07 [h])

- This is the month counter.
It is updated in annual cycles of regularly ordered months (January, February, March, etc.).

3) [YEAR] register (Reg – 08 [h])

- This is the year counter.
It is updated in 100-year cycles of regularly ordered years (00, 01, 02 to 99, etc.).
- * Any year that is a multiple of four (04, 08, 12, 88, 92, 96, etc.) is handled as a leap year.

4) C bit (Century bit)

- This bit indicates change of century.
- * When the year digit data overflows from 99 to 00, this bit is set. By presetting it to 0 while still in the 20th century, it will be set in year 2000, but in fact the first year in the 21 century should be 2001.

13.1.5. Day counter (Reg – 6[h])

Address [h]	Function	bit 7	bit 6	bit 5	bit 4	bit 3	bit 2	bit 1	bit 0
06	Weekdays	×	×	×	×	×	4	2	1

- The day (of the week) is indicated by 3 bits, bit 0 to bit 2.

[Weekdays]	bit 7	bit 6	bit 5	bit 4	bit 3	bit 2	bit 1	bit 0	Day
Write / Read	×	×	×	×	×	0	0	0	Sunday
	×	×	×	×	×	0	0	1	Monday
	×	×	×	×	×	0	1	0	Tuesday
	×	×	×	×	×	0	1	1	Wednesday
	×	×	×	×	×	1	0	0	Thursday
	×	×	×	×	×	1	0	1	Friday
	×	×	×	×	×	1	1	0	Saturday

- * Note with caution that any settings other than the seven listed above may prevent normal operation.

13.1.6. Alarm registers (Reg – 09 [h] to 0C [h])

Address [h]	Function	bit 7	bit 6	bit 5	bit 4	bit 3	bit 2	bit 1	bit 0
09	Minute Alarm	AE	40	20	10	8	4	2	1
0A	Hour Alarm	AE	×	20	10	8	4	2	1
0B	Day Alarm	AE	×	20	10	8	4	2	1
0C	Weekday Alarm	AE	×	×	×	×	4	2	1

- The AIE bit and AF bit can both be set or used when using alarm interrupt function to set interrupt events for dates, days, hours, minutes, etc.
- When the current time matches the settings in the above alarm registers, the AF bit's value is "1" and the /INT pin's status is low to indicate that an alarm interrupt event has occurred.

* For details, see "9.3. Alarm Interrupt Function".

13.1.7. Timer setting register (Reg – 0E [h])

Address [h]	Function	bit 7	bit 6	bit 5	bit 4	bit 3	bit 2	bit 1	bit 0
0E	Timer control	TE	×	×	×	×	×	TD1	TD0

- This register is used to control the fixed-cycle timer interrupt function.
- To use the fixed-cycle timer interrupt function, the TI/TP bits (Reg – 01 [h]), timer register (Reg – 0F [h]), and the TF and TIE bits are all set or used.

1) TE bit (Timer Enable)

This bit is used to control operation of the fixed-cycle timer interrupt function.
 When "1" is written to this bit, the fixed-cycle timer interrupt function starts operating.
 When "0" is written to this bit, the fixed-cycle timer interrupt function stops operating.

* For details, see "9.2. Fixed-cycle Timer Interrupt Function".

2) TD1,TD0 bits (Timer countDown interval select 1, 0)

These bits specify the fixed-cycle timer interrupt function's countdown period (source clock).
 Four different periods can be selected via combinations of these two bit values.

* For details, see "9.2. Fixed-cycle Timer Interrupt Function".

13.1.8. Down counter for fixed-cycle timer (Reg – 0F [h])

Address [h]	Function	bit 7	bit 6	bit 5	bit 4	bit 3	bit 2	bit 1	bit 0
0F	Timer	128	64	32	16	8	4	2	1

- This register is used to set the default (preset) value for the counter. Any count value from 1 (01h) to 255 (FFh) can be set
- To use the fixed-cycle timer interrupt function, the TE, TI/TP, TF, TIE, TD1, and TD0 bits are set and used.
- When this down counter's count value changes from 01h to 00h, when TF bit = "1", or when the /INT pin is at low level ("L"), it indicates that a fixed-cycle timer interrupt event has occurred.
- The current countdown status can be checked by reading this register.
 - * However, since the read data is not held (the data may be changing), to obtain accurate data the countdown status should be read twice and then compared.

* For details, see "9.2. Fixed-cycle Timer Interrupt Function".

13.1.9. CLKOUT output register (Reg - 0D [h])

Address [h]	Function	bit 7	bit 6	bit 5	bit 4	bit 3	bit 2	bit 1	bit 0
0D	CLKOUT frequency	FE	×	×	×	×	×	FD1	FD0

- This register is used to control clock output via the CLKOUT output pin.
- This register is valid only when the CLKOE input pin is at high level, at which time clock output is enabled or disabled (stopped) depending on the settings in this register.
 - * When the CLKOE input pin is at low level, CLKOUT is at low level regardless of the settings in this register.

1) FE bit (Frequency output Enable)

When this register is valid (when CLKOE is at high level), it is used to control the CLKOUT pin's output status.
 When the FE bit value is "1", the CLKOUT pin is in output mode. The content being output at that time is the frequency specified via the FD1 and FD0 bit.
 When the FE bit value is "0", the CLKOUT pin is output STOP mode (= low level).

2) FD1, FD0 bits

A combination of the FD1 and FD0 bits is used to select the frequency to be output.

3) CLKOUT output based on various settings

CLKOE pin input	FE bit	FD1 bit	FD0 bit	CLKOUT pin output
" H "	1	0	0	32768 Hz Output (C-MOS)
		0	1	1024 Hz Output (C-MOS)
		1	0	32 Hz Output (C-MOS)
		1	1	1 Hz Output (C-MOS)
" L "	0	X	X	OFF (" L ")
	1	X	X	OFF (" L ")
" L "	0	X	X	OFF (" L ")
	1	X	X	OFF (" L ")

X : don't care

- * During initial power-on (from 0 V), "1" is set to the FE bit by the power-on reset function, and the FD1 and FD0 bits are reset to zero.
 Consequently, 32.768 kHz output can be obtained from the CLKOUT output pin by setting the CLKOE input pin to high level.

Note) Re: CLKOUT output operation when STOP bit value is "1"

Note with caution that when the STOP bit value is "1", output via CLKOUT may be stopped, depending on the selected frequency.

- (1) When 32.768 kHz output has been selected, output continues at 32.768 kHz.
- (2) When any other frequency has been set (1024Hz, 32Hz, or 1Hz), CLKOUT output is stopped.

13.2. Fixed-cycle Timer Interrupt Function

The fixed-cycle timer interrupt function generates an interrupt event periodically at any fixed cycle set between 244.14 μ s and 255 minutes.

There are two operation modes: "level interrupt mode" whereby the operation ends after one time, and "repeated interrupt mode" whereby the operation is automatically repeated.

When either of these interrupt events occurs, the event's occurrence is indicated by the "1" value set to the TF bit and by the low-level ("L") status of the /INT pin.

13.2.1. Overview of fixed-cycle timer interrupt function

- The fixed-cycle timer interrupt function is used with several combinations of settings.
 - (1) Operation mode setting (level interrupt mode or repeated interrupt mode)
 - (2) Fixed-cycle timer operation period setting (period = countdown reference cycle \times count value)
 - (3) Setting as to whether to output (at low level) an interrupt signal from the /INT output pin after a specified amount of operation time has elapsed.
- When operation of the fixed-cycle timer starts (TE, "0" \rightarrow "1"), various events occur after the specified time has elapsed.
 - (1) The TF (Timer Flag) bit value, which indicates when a fixed-cycle timer interrupt event has occurred, changes from "0" to "1".
 - (2) When the TIE (Timer Interrupt Enable) bit value is "1", the /INT output pin status changes from Hi-Z to "L".

1) Overview of level interrupt mode (TI/TP bit = "0")

Once an interrupt event has occurred, the operation ends after one iteration.

* However, if only the TF bit is cleared to zero without stopping operation of the fixed-cycle timer (TE bit value remains "1"), note with caution that an interrupt event will occur during the next timer cycle (period).

If an interrupt event occurs during level interrupt mode, the /INT output goes to low level.

The low level output is maintained as it is until the TF bit is cleared to zero. (When TIE = "1")

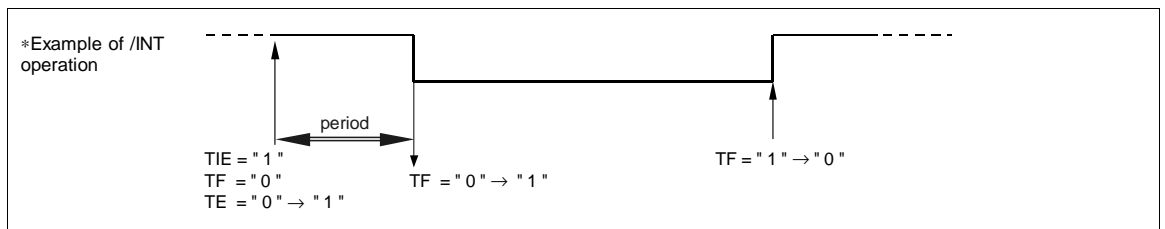

2) Overview of repeated interrupt mode (TI/TP bit = "1")

After an interrupt event occurs, the operation is automatically repeated.

When an interrupt event occurs during repeated interrupt mode, /INT output goes to low level only during the tRTN period, and then it is automatically canceled and returns to Hi-Z status.

However, even after returning to Hi-Z status, similar /INT output is obtained after the next interrupt event occurs.

Afterward, this is repeated until fixed-cycle timer operation is stopped.

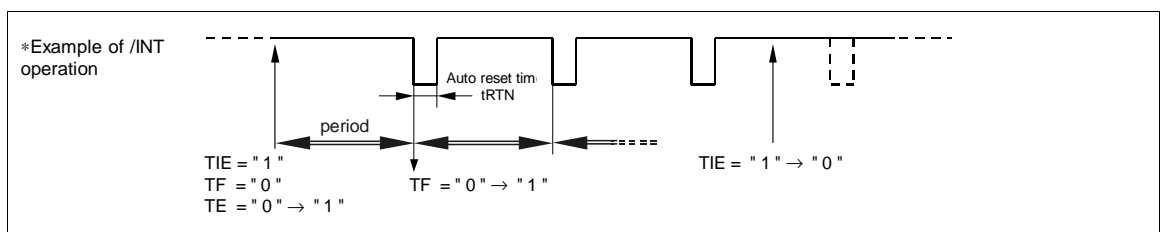

3) Overview of fixed-cycle timer interrupt function

- (1) Changing the TE (Timer Enable) bit value from "0" to "1" starts operation of the fixed-cycle timer interrupt function.

* Before starting the fixed-cycle timer interrupt function each time, be sure to write a value (preset value/Reg-0F[h]) as the down counter value for the timer (when TE = "0").

(Note) Note with caution that the preset value must be set or reset to enable correct operation.

- (2) When the TE bit = "1", the timer's down counter (Timer Register/Reg – 0F[h]) counts down once per cycle (countdown cycle) of the source clock that was selected via the TD1 and TD0 bits (Timer countdown interval select bits 1 and 0).

* Timer cycle (Period) = Source clock × value (preset value) set to timer's down counter

- (3) The following processing is executed after an event is triggered by the countdown reaching a count value of "0".

*1) The TF (Timer Flag) bit value becomes "1".

*2) When the TIE (Timer Interrupt Enable) bit value becomes "1", the /INT output pin's status changes from Hi-z to "L".

* After the /INT output pin's status changes from Hi-z to "L", the /INT status is either held at low level or automatically cleared, depending on the TI/TP bit's setting from the operation mode (level interrupt mode or repeated interrupt mode).

*3) The timer's down counter automatically returns to the preset value and then the countdown operation is repeated.

* When the TE bit value is "1", countdown operation of the timer's down counter will be repeated regardless of the operation mode or of any event that has occurred.

- (4) When the TE bit is cleared from "1" to 0", the fixed-cycle timer interrupt function stops.

*1) The TF bit value remains "1" until it is cleared to zero (even if the fixed-cycle timer function has been stopped).

*2) The timer's down counter value becomes invalid once the fixed-cycle timer function has been stopped.

* When the fixed-cycle timer interrupt function is stopped, the timer's down counter value and the preset value both become invalid.

* The preset value must be written again (when TE = "0") in order to start the fixed-cycle timer interrupt function again.

* Operation example

Operation example during repeated interrupt mode and when preset value is "5" (05h).

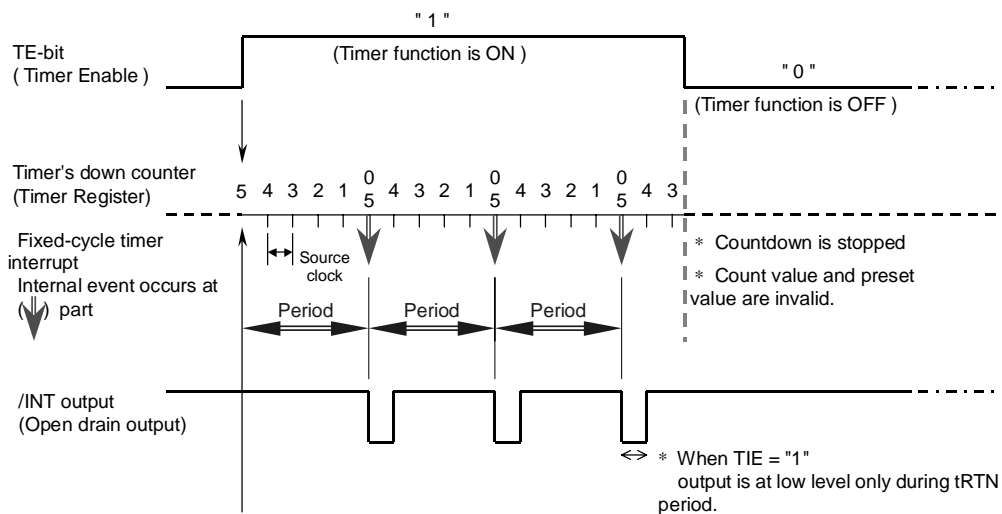

* When the TE-bit is changed to "1", the countdown starts from the preset value, which is "5" (05h) in this example.

13.2.2. Related registers for function of timer interrupts.

Address [h]	Function	bit 7	bit 6	bit 5	bit 4	bit 3	bit 2	bit 1	bit 0
01	Control 2	0	×	0	TI / TP	AF	TF	AIE	TIE
0E	Timer control	TE	×	×	×	×	×	TD1	TD0
0F	Timer	128	64	32	16	8	4	2	1

* Before starting the fixed-cycle timer interrupt function each time, be sure to write a value (preset value/Reg-0F[h]) as the timer's down counter value (when TE = "0").

(Note) Note with caution that the preset value must be set or reset to enable correct operation.

* Before entering operation settings, we recommend first clearing the TE bit to "0" and then clearing the TF and TIE bits to "0" in that order, so that all control-related bits are zero-cleared (= set to operation stop mode) to prevent hardware interrupts from occurring inadvertently while entering settings.

1) TI / TP bit (Interrupt Signal Output Mode Select. Interrupt / Periodic)

When a fixed-cycle timer interrupt event occurs, this bit selects whether to end the operation after one iteration or to repeat the operation.

TI / TP	Data	Description
Write / Read	0	[Level interrupt mode] Fixed-cycle timer interrupt function operates one time only ^(*) *) Another operation can be set via various bit settings.
	1	[Repeated interrupt mode] Fixed-cycle timer interrupt function operates repeatedly

2) TD1, TD0 bits (Timer countDown interval select 1, 0)

These bits specify the fixed-cycle timer interrupt function's countdown period (source clock). Four different periods can be selected via combinations of these two bit values.

TD1, TD0	TD1 (bit 1)	TD0 (bit 0)	Source clock	/INT auto recovery time tRTN during repeated interrupt mode	
				Preset value n = 1	Preset value 1 < n
W / R	0	0	4096 Hz / 244.14 μs cycle	122 μs	244 μs
	0	1	64 Hz / 15.625 ms cycle	7.813 ms	15.625 ms
	1	0	1 Hz / Updated per second	15.625 ms	15.625 ms
	1	1	1/60 Hz / Updated per minute	15.625 ms	15.625 ms

*1) During repeated interrupt mode (TI/TP bit = "1"), the auto recovery time tRTN (when the /INT pin is switched from low level to Hi-Z) varies according to the source clock and preset value, as shown above.

*2) The countdown when a 1-Hz source clock has been selected is linked to updating of the internal clock's seconds setting.

* Since the internal clock is linked to updating of the seconds setting, if the timer is started at a clock time of 0.9 seconds, the first countdown will occur only 0.1 second later. (The second and subsequent countdowns will occur at the correct time interval.)

*2) The countdown when a 1/60-Hz source clock has been selected is linked to updating of the internal clock's minutes setting.

* Since the internal clock is linked to updating of the minutes setting, if the timer is started at a clock time of 50 seconds, the first countdown will occur only 10 seconds later. (The second and subsequent countdowns will occur at the correct time interval.)

3) Down counter for fixed-cycle timer (Timer Register)

This register is used to set the default (preset) value for the counter. Any count value from 1 (01 h) to 255 (FFh) can be set

When the fixed-cycle timer interrupt function is operating, the down counter counts down one step per source clock cycle, and when the count value goes from 01h to 00h, an event such as changing the TF bit value to "1" occurs.

- * When the fixed-cycle timer function has been stopped (when the TE bit value has been changed from "1" to "0"), the timer's down counter value and preset value both become invalid.
- * The preset value must be written again (when TE = "0") in order to start the fixed-cycle timer interrupt function again.
- * The status during a countdown can be checked by reading this register.
(However, since the read data is not held (the data may be changing), to obtain accurate data the countdown status should be read twice and then compared.)

4) TE bit (Timer Enable)

This bit enables operation of the of the fixed-cycle timer interrupt function to start.

TE	Data	Description
Write / Read	0	Stops fixed-cycle timer interrupt function
	1	Starts fixed-cycle timer interrupt function

5) TF bit (Timer Flag)

This is a flag bit that retains the result when a fixed-cycle timer interrupt event is detected.

If it was already cleared to zero, this value changes from "0" to "1" when an event occurs, and the new value is retained.

TF	Data	Description
Write	0	The TF bit is cleared to zero (to cancel the interrupt event), to prepare for the next event detection. Note) Even after the interrupt event has been canceled, the fixed-cycle timer function operates continuously as long as the TE bit (Timer Enable) value is "1". * Level interrupt mode (single-shot operation) 1) Clearing the TF bit to zero cancels the low-level status of the /INT pin (the /INT pin goes to Hi-Z status) . 2) When the TE bit value remains "1", the timer's down counter continues to count down, and when the counter value goes form 01h to 00h, the TF bit value is again changed to "1", the /INT pin goes to low level, and an event occurs.
	1	This bit is invalid after a "1" has been written to it.
Read	0	Fixed-cycle timer interrupt events are not detected.
	1	Fixed-cycle timer interrupt events are detected. * Result is retained until this bit is cleared to zero

13.4. /INT "L" Interrupt Output When Interrupt Function Operates

1) Setting interrupt events to occur in response to /INT "L" interrupt output

The /INT interrupt output pin is shared as the output pin for two kinds of interrupt events: events related to the fixed-cycle timer interrupt function and events related to the alarm interrupt function.

When an interrupt occurs (when /INT is at low level ("L")), read the TF and AF flags to determine which type of interrupt event occurred (which flag value changed to "1").

2) How to prevent /INT pin from going to low level ("L")

To prevent the /INT pin from going to low level ("L"), clear all TIE and AIE bits to zero.

To detect when an interrupt event has occurred without having to set the /INT pin to low level, monitor the TF and AF flag bit values to see if the target interrupt event has occurred (i.e., to see if either flag bit value changes from "0" to "1").

3) Example of processing to recover from backup mode

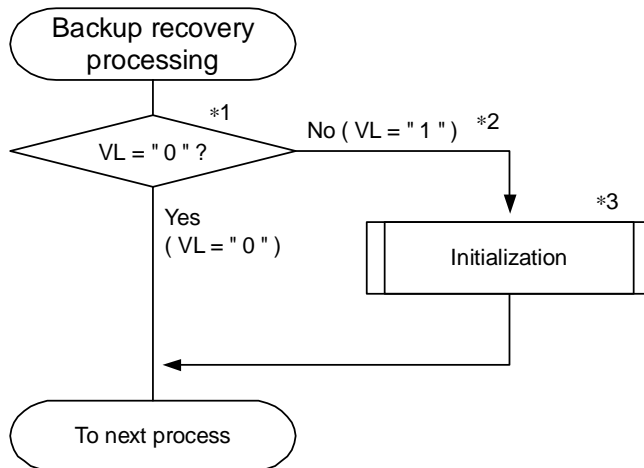

- *1) Check the VL bit (Voltage Low Flag).
- *2) When the VL bit = "1", it may be due to an error during backup (clock data or register settings may have been lost, due to a voltage drop, etc.), so be sure to initialize.
- *3) Be sure to initialize all registers. (For further description of initialization, see "Initialization" below.)

4) Example of clock and calendar write processing

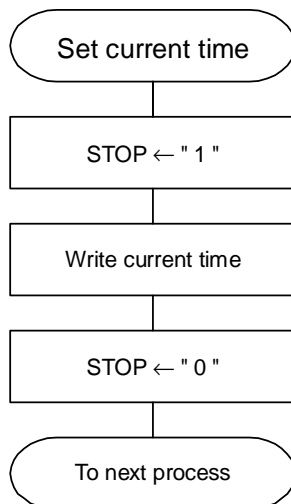

- Write "1" to the STOP bit to prevent clock updates while setting the current time.
- Write the data (among the [Year/Month/Day [day of week]:hour:minute:second] data) that needs to be set (or reset).
* When initializing be sure to initialize all of the data.
- Zero-clear the STOP bit to start (restart) the clock's operation.
* The clock starts from the set [second] + 500 ms (500 ms after the set second). (The first [second] update occurs 500 ms later.)

5) Example of clock and calendar read processing

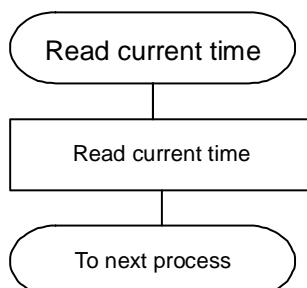

- The required information (among the [Year/Month/Day [day of week]:hour:minute:second] data) is read within one second.
* There is no need to manipulate the STOP bit.

6) Example of timer interrupt function setting

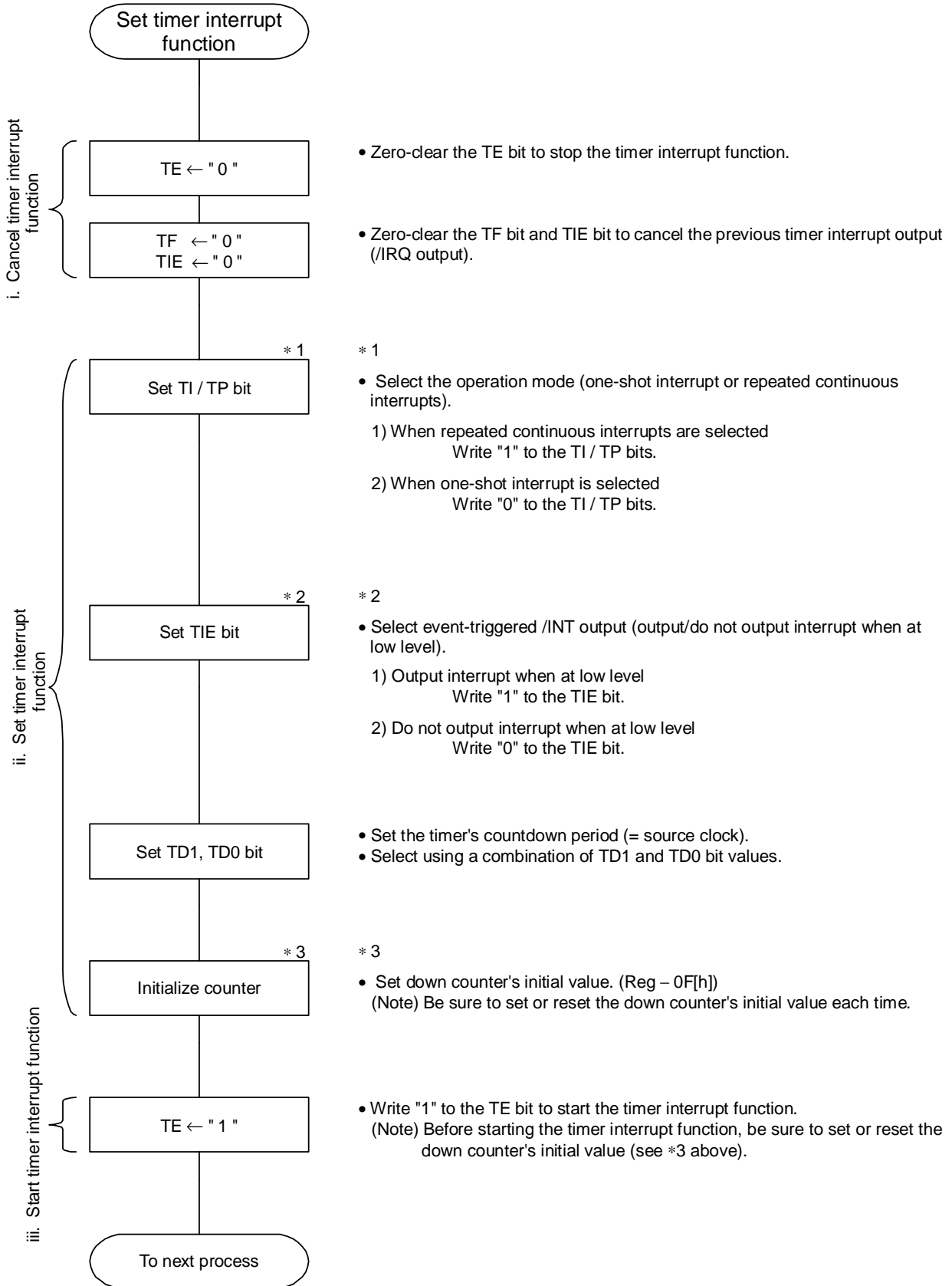

13.6. Reading/Writing Data via the I²C Bus Interface

13.6.1. Overview of I2C-BUS

The I²C bus supports bi-directional communications via two signal lines: the SDA (data) line and SCL (clock) line. A combination of these two signals is used to transmit and receive communication start/stop signals, data transfer signals, acknowledge signals, and so on.

Both the SCL and SDA signals are held at high level whenever communications are not being performed. The starting and stopping of communications is controlled at the rising edge or falling edge of SDA while SCL is at high level.

During data transfers, data changes that occur on the SDA line are performed while the SCL line is at low level, and on the receiving side the data is output while the SCL line is at high level.

The I²C bus device does not include a chip select pin such as is found in ordinary logic devices. Instead of using a chip select pin, slave addresses are allocated to each device and the receiving device responds to communications only when its slave address matches the slave address in the received data. In either case, the data is transferred via the SCL line at a rate of one bit per clock pulse.

13.6.2. System configuration

All ports connected to the I²C bus must be either open drain or open collector ports in order to enable AND connections to multiple devices.

SCL and SDA are both connected to the VDD line via a pull-up resistance. Consequently, SCL and SDA are both held at high level when the bus is released (when communication is not being performed).

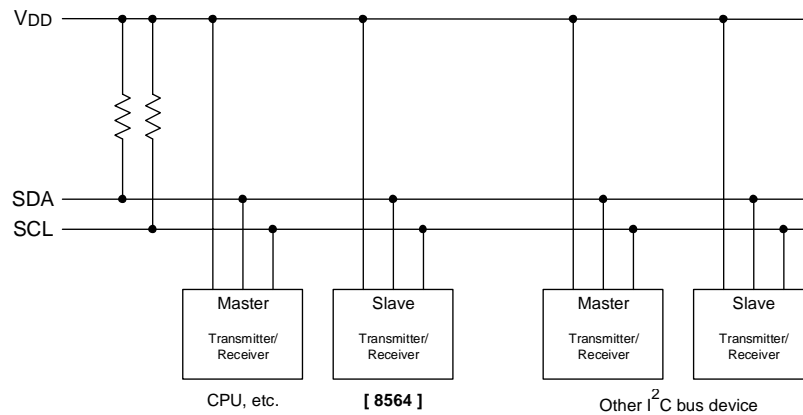

Any device that controls the data transmission and data reception is defined as a "Master".

and any device that is controlled by a master device is defined as a "Slave".

The device transmitting data is defined as a "Transmitter" and the device receiving data is defined as a receiver"

In the case of this RTC module, controllers such as a CPU are defined as master devices and the RTC module is defined as a slave device. When a device is used for both transmitting and receiving data, it is defined as either a transmitter or receiver depending on these conditions.

13.6.3. Starting and stopping I2C bus communications

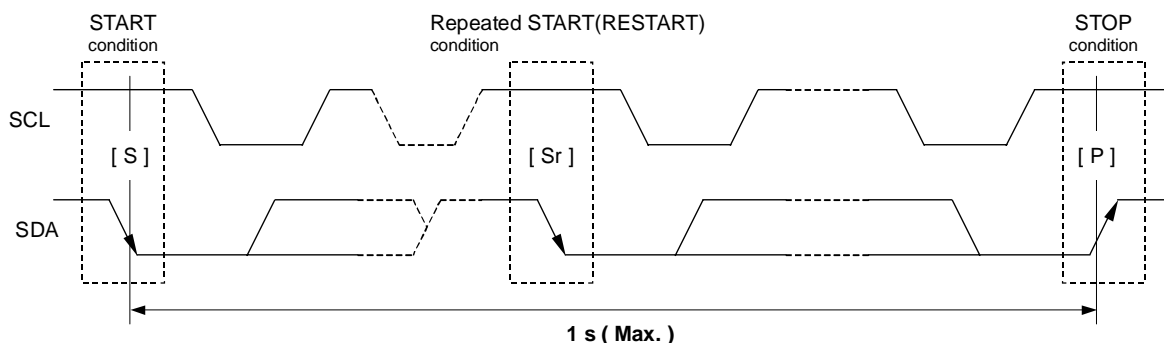

1) START condition, repeated START condition, and STOP condition

(1) START condition

- The SDA level changes from high to low while SCL is at high level.

(2) STOP condition

- This condition regulates how communications on the I²C-BUS are terminated. The SDA level changes from low to high while SCL is at high level.

(3) Repeated START condition (RESTART condition)

- In some cases, the START condition occurs between a previous START condition and the next STOP condition, in which case the second START condition is distinguished as a RESTART condition. Since the required status is the same as for the START condition, the SDA level changes from high to low while SCL is at high level.

2) Caution points

- *1) The master device always controls the START, RESTART, and STOP conditions for communications.
- *2) The master device does not impose any restrictions on the timing by which STOP conditions affect transmissions, so communications can be forcibly stopped at any time while in progress. (However, this is only when this RTC module is in receiver mode (data reception mode = SDA released).)
- *3) When communicating with this RTC module, the series of operations from transmitting the START condition to transmitting the STOP condition should occur **within 1 seconds**. (A RESTART condition may be sent between a START condition and STOP condition, but even in such cases the series of operations from transmitting the START condition to transmitting the STOP condition should still occur **within 1 seconds**.)

If this series of operations requires **1 seconds or longer**, the I²C bus interface will be automatically cleared and set to standby mode by this RTC module's bus timeout function. Note with caution that both write and read operations are invalid for communications that occur during or after this auto clearing operation. (When the read operation is invalid, all data that is read has a value of "1"). Restarting of communications begins with transfer of the START condition again

- *4) When communicating with this RTC module, wait **at least 1.3 μs (see the tBUF rule)** between transferring a STOP condition (to stop communications) and transferring the next START condition (to start the next round of communications).

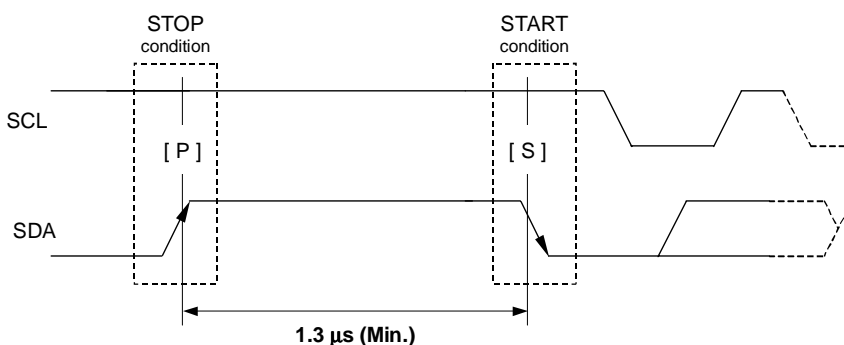

13.6.4. Data transfers and acknowledge responses during I2C-BUS communications

1) Data transfers

Data transfers are performed in 8-bit (1 byte) units once the START condition has occurred. There is no limit on the amount (bytes) of data that are transferred between the START condition and STOP condition. **(However, the transfer time must be no longer than 1 seconds.)**

The address auto increment function operates during both write and read operations. **After address Fh, incrementation goes to address 0h.**

Updating of data on the transmitter (transmitting side)'s SDA line is performed while the SCL line is at low level. The receiver (receiving side) receives data while the SCL line is at high level.

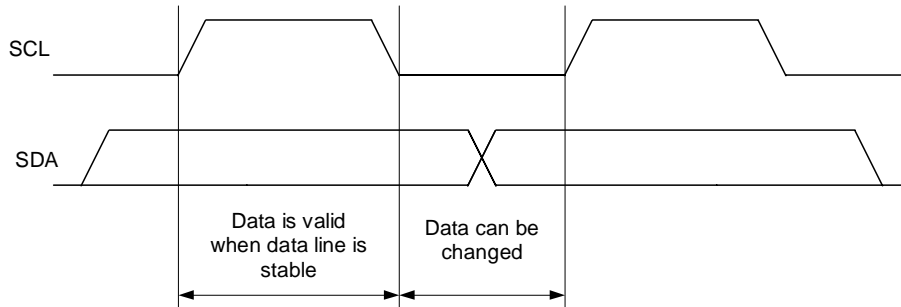

* Note with caution that if the SDA data is changed while the SCL line is at high level, it will be treated as a START, RESTART, or STOP condition.

2) Data acknowledge response (ACK signal)

When transferring data, the receiver generates a confirmation response (ACK signal, low active) each time an 8-bit data segment is received. If there is no ACK signal from the receiver, it indicates that normal communication has not been established. (This does not include instances where the master device intentionally does not generate an ACK signal.)

Immediately after the falling edge of the clock pulse corresponding to the 8th bit of data on the SCL line, the transmitter releases the SDA line and the receiver sets the SDA line to low (= acknowledge) level.

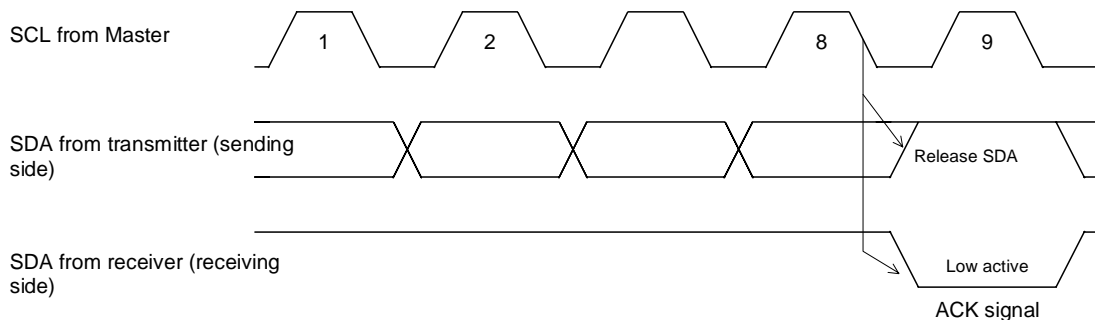

After transmitting the ACK signal, if the Master remains the receiver for transfer of the next byte, the SDA is released at the falling edge of the clock corresponding to the 9th bit of data on the SCL line. Data transfer resumes when the Master becomes the transmitter.

When the Master is the receiver, if the Master does not send an ACK signal in response to the last byte sent from the slave, that indicates to the transmitter that data transfer has ended. At that point, the transmitter continues to release the SDA and awaits a STOP condition from the Master.

13.6.5. Slave address

The I²C bus device does not include a chip select pin such as is found in ordinary logic devices. Instead of using a chip select pin, slave addresses are allocated to each device.

All communications begin with transmitting the [START condition] + [slave address (+ R/W specification)]. The receiving device responds to this communication only when the specified slave address it has received matches its own slave address.

Slave addresses have a fixed length of 7 bits. This RTC's slave address is **[1010 001*]**.

An R/W bit ("*" above) is added to each 7-bit slave address during 8-bit transfers.

	Transfer data	Slave address							R/W bit
		bit 7	bit 6	bit 5	bit 4	bit 3	bit 2	bit 1	bit 0
Read	A3 h	1	0	1	0	0	0	1	1 (= Read)
Write	A2 h								0 (= Write)

13.6.6. I²C bus protocol

In the following sequence descriptions, it is assumed that the CPU is the master and the [8564] is the slave.

1) Address specification write sequence

Since the [8564] includes an address auto increment function, once the initial address has been specified, the [8564] increments (by one byte) the receive address each time data is transferred.

- (1) CPU transfers start condition [S].
- (2) CPU transmits the [8564] 's slave address with the R/W bit set to write mode.
- (3) Check for ACK signal from [8564] .
- (4) CPU transmits write address to [8564] .
- (5) Check for ACK signal from [8564] .
- (6) CPU transfers write data to the address specified at (4) above.
- (7) Check for ACK signal from [8564] .
- (8) Repeat (6) and (7) if necessary. Addresses are automatically incremented.
- (9) CPU transfers stop condition [P].

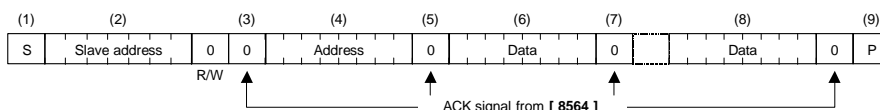

2) Address specification read sequence

After using write mode to write the address to be read, set read mode to read the actual data.

- (1) CPU transfers start condition [S].
- (2) CPU transmits the [8564] 's slave address with the R/W bit set to write mode.
- (3) Check for ACK signal from [8564] .
- (4) CPU transfers address for reading from [8564] .
- (5) Check for ACK signal from [8564] .
- (6) CPU transfers RESTART condition [Sr] (in which case, CPU does not transfer a STOP condition [P]).
- (7) CPU transfers [8564] 's slave address with the R/W bit set to read mode.
- (8) Check for ACK signal from [8564] (from this point on, the CPU is the receiver and the [8564] is the transmitter).
- (9) Data from address specified at (4) above is output by the [8564] .
- (10) CPU transfers ACK signal to [8564] .
- (11) Repeat (9) and (10) if necessary. Read addresses are automatically incremented.
- (12) CPU transfers ACK signal for "1".
- (13) CPU transfers stop condition [P].

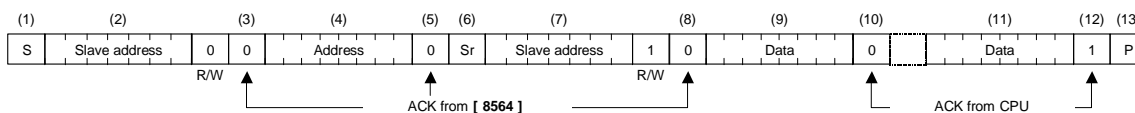

3) Read sequence when address is not specified

Once read mode has been initially set, data can be read immediately. In such cases, the address for each read operation is the previously accessed address + 1.

- (1) CPU transfers start condition [S].
- (2) CPU transmits the [8564] 's slave address with the R/W bit set to read mode.
- (3) Check for ACK signal from [8564] (from this point on, the CPU is the receiver and the [8564] is the transmitter).
- (4) Data is output from the [8564] to the address following the end of the previously accessed address.
- (5) CPU transfers ACK signal to [8564] .
- (6) Repeat (4) and (5) if necessary. Read addresses are automatically incremented in the [8564] .
- (7) CPU transfers ACK signal for "1".
- (8) CPU transfers stop condition [P].

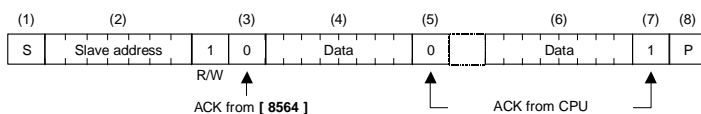

Application Manual

AMERICA

EPSON ELECTRONICS AMERICA, INC.

HEADQUARTER	2580 Orchard Parkway, San Jose, CA 95131, U.S.A. Phone: (1)800-228-3964 (Toll free) : (1)408-922-0200 (Main) Fax: (1)408-922-0238 http://www.eea.epson.com
Atlanta Office	One Crown Center 1895 Phoenix Blvd. Suite 348 Atlanta, GA 30349 Phone: (1)800-228-3964 (Toll free) : (1)770-907-7667 (Main)
Boston Office	301 Edgewater Place, Ste. 120, Wakefield, MA 01880, U.S.A. Phone: (1)800-922-7667 (Toll free) : (1)781-246-3600 (Main) Fax: (1)781-246-5443
Chicago Office	1827 Walden Office Square, Suite 450 Schaumburg, IL 60173 Phone: (1)847-925-8350 Fax: (1)847-925-8965
El Segundo Office	1960 E. Grand Ave., 2nd Floor, El Segundo, CA 90245, U.S.A. Phone: (1)800-249-7730 (Toll free) : (1)310-955-5300 (Main) Fax: (1)310-955-5400

EUROPE

EPSON EUROPE ELECTRONICS GmbH

HEADQUARTER	Riesstrasse 15, 80992 Munich, Germany Phone: (49)-(0)89-14005-0 Fax: (49)-(0)89-14005-110 http://www.epson-electronics.de
--------------------	---

ASIA

EPSON (CHINA) CO., LTD.

23F, Beijing Silver Tower 2# North RD DongSangHuan ChaoYang District, Beijing, China
Phone: (86) 10-6410-6655 Fax: (86) 10-6410-7319

Shanghai Branch

<http://www.epson.com.cn>
High-Tech Building, 900 Yishan Road Shanghai 200233, China
Phone: (86) 21-5423-5577 Fax: (86) 21-5423-4677

EPSON HONG KONG LTD.

20/F., Harbour Centre, 25 Harbour Road, Wanchai, Hong Kong
Phone: (852) 2585-4600 Fax: (852) 2827-2152

<http://www.epson.com.hk>

EPSON ELECTRONIC TECHNOLOGY DEVELOPMENT (SHENZHEN) CO., LTD.

12/F, Dawning Mansion, #12 Keji South Road, Hi-Tech Park, Shenzhen, China
Phone: (86) 755-26993828 Fax: (86) 755-26993838

EPSON TAIWAN TECHNOLOGY & TRADING LTD.

14F, No.7, Song Ren Road, Taipei 110
Phone: (886) 2-8786-6688 Fax: (886) 2-8786-6660

<http://www.epson.com.tw>

EPSON SINGAPORE PTE. LTD.

No 1 HarbourFront Place, #03-02 HarbourFront Tower One, Singapore 098633.
Phone: (65) 6586-5500 Fax: (65) 6271-3182

<http://www.epson.com.sg>

SEIKO EPSON CORPORATION KOREA Office

50F, KLI 63 Building, 60 Yoido-dong, Youngdeungpo-Ku, Seoul, 150-763, Korea
Phone: (82) 2-784-6027 Fax: (82) 2-767-3677

<http://www.epson-device.co.kr>

Gumi Branch Office

2F, Grand Bldg, 457-4, Songjeong-dong Gumi-City, Gyongsangbuk-Do,
730-090, Korea
Phone: (82) 54-454-6027 Fax: (82) 54-454-6093

EPSON TOYOCOM CORPORATION

Distributor

Electronic devices information on WWW server

<http://www.epsontoyocom.co.jp>